



Traverse®

60" x 30" ADA bath/shower LH drain, grab bars, seat
71570115



Features

- Tongue-and-groove modular design allows for easy installation during any phase of construction.
- Modern subway tile design.
- Full-length shelf provides generous storage.
- Easy-to-clean, durable high-gloss finish.
- Stainless steel grab bars and bath seat.

Material

- Compression molded from our exclusive solid Vikrell® material.

Installation

- Pro4™ installation system features a two-piece back wall design, enabling one-person handling and installation.
- Alcove.
- Caulk-free installation.
- Left drain.



Recommended Products/Accessories

- K-23726 Drain treatment
- K-23723 Faucet cleaner
- K-23733 Vikrell® cleaner

Included Components

Product consists of:

- 71171110
- 71574106
- 71577103
- 71177104

ADA

Codes/Standards



- CSA B45.5/IAPMO Z124
- ASTM E162
- ASTM E662
- ADA
- ICC/ANSI A117.1
- HUD, UM Bulletin 73

STERLING® Vikrell® or Acrylic Baths and Shower Bases Ten-Year Limited Warranty
STERLING® Grab Bars Ten-Year Limited Warranty
STERLING® Non-Vikrell® Bathing & Showering Seats Ten-Year Limited Warranty

See website for detailed warranty information.

Available Colors/Finishes

Color tiles intended for reference only.

Color	Code	Description
	0	White
	96	KOHLER Biscuit

1-800-STERLING (1-800-783-7546)

Kohler Co. reserves the right to make revisions without notice to product specifications.

For the most current Specification Sheet, go to www.sterlingplumbing.com.

10-2-2022 20:58 - US/CA

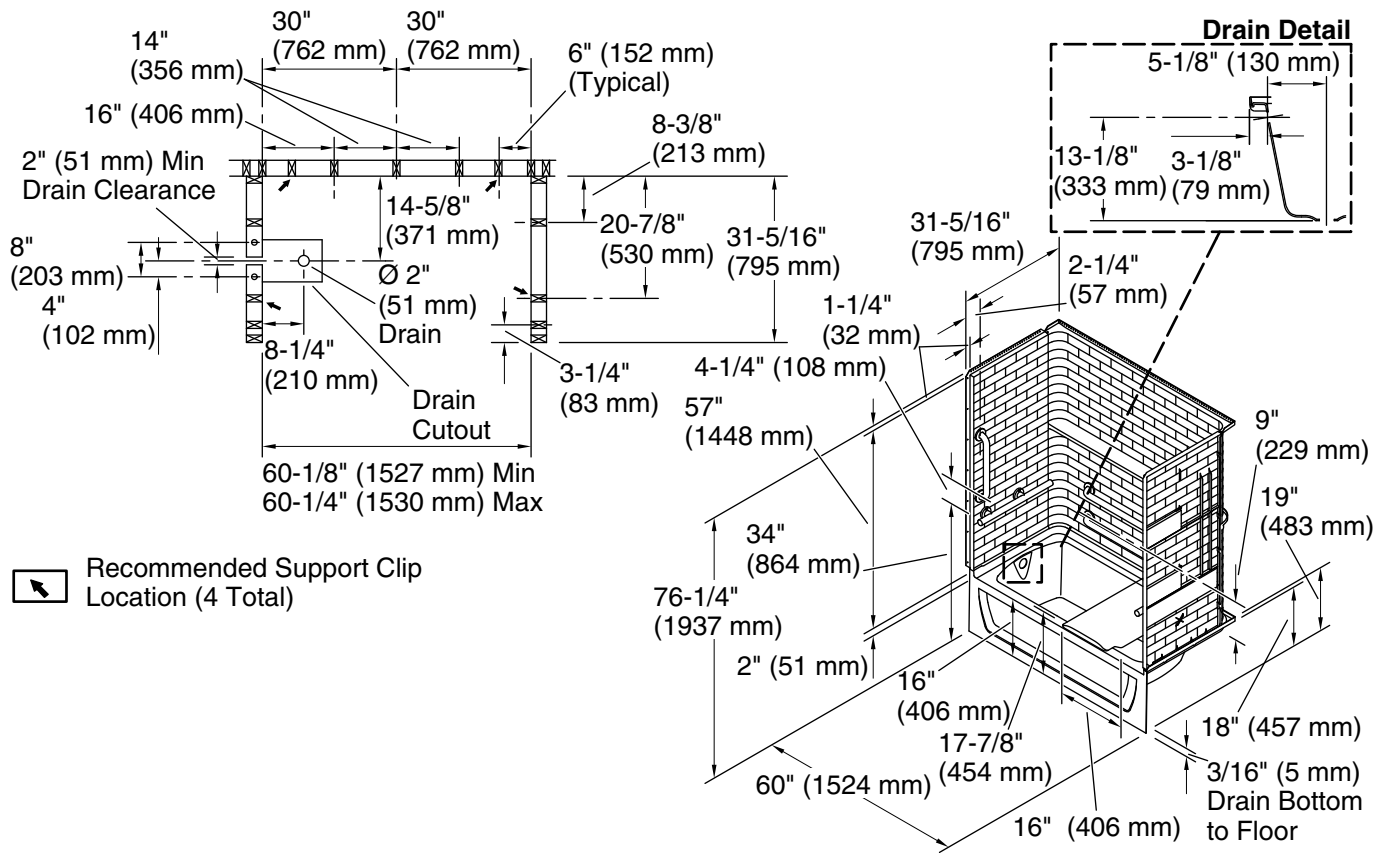

Technical Information

All product dimensions are nominal.
Installation: Three-wall alcove

Notes

Install this product according to the installation instructions.
Studs should be positioned roughly as shown. Double studding is recommended for pivot shower door installations.
ADA compliant when installed to the specific requirements of these regulations.